

Series **400B**

product guide

features

- 56' Three-section boom
- 10 Ton rating
- Internal anti-two-block
- Self-lubricating "Easy Glide" wear pads



contents

Features

2

Mounting Configurations

3

Specifications

4

Capacities: With 18' Jib

5

Capacities: No Jib

6

Accessories

7

features

Why Buy a National Series 400B?

2



*Product may be shown with optional equipment.

- **10 ton Rating** – The 400B provides a 10-ton capacity at a five-foot radius.
- **Self-lubricating “Easy glide” Wear Pads** – The self-lubricating pads, standard on the 400B, reduce the conditions that cause boom chatter and vibration. The net result is smoother crane operation.
- **Internal Anti-two-block** – The patent-pending design, standard on the 400B, eliminates the external reel and wire. No more snagging the reel or wire on obstructions.
- **Speedy-reeve Boom Tip and Sheave Blocks** – These standard features simplify rigging changes.
- **Pre-painted Components** – Painting crane components before assembly reduces the possibility of rust, improves serviceability and enhances the appearance of the machine.
- **Large Oil Reservoir** – Helps reduce heat build-up.
- **Redesigned Frame and Console** – Control valve is now mounted in the console, making it much easier to service.
- **Oil Filter** – The oil filter is now mounted at the tank, not in the crane frame. Filler cap is anti-splash. Reservoir has a stainless steel strainer on fill port.
- **Increased Space Inside Frame** – More room inside the frame makes the unit more easily serviceable.
- **Wiring Harness** – New crane wiring harness simplifies design and cleans up inside of console, providing easy access and service.
- **Improved Serviceability** –
 - A removable winch allows the internal telescoping cylinder to be removed quickly, without dismantling the boom.
 - Bearings on the boom extend and retract cables can be greased through access holes in the boom side plates.
 - Internal anti-two-block wire routing eliminates damage potential from external contact.
 - The boom sheave case is open, allowing access to replace the internal anti-two-block wire and to observe internal boom components.
 - Pre-paint reduces rust.
 - Internal boom parts have been reduced, facilitating rebuilding the machine.
- **National Crane Is the Market Leader** – National is number one in the production of commercial truck-mounted boom trucks. National has many programs and people directly and indirectly involved to provide our customers reliable products.
 - National has the boom truck industry’s leading test program. Every structural part of the crane is cycle tested up to 60,000 cycles at full capacity. In addition to cycle testing, each model is subjected to state-of-the-art strain gauge testing that measures metal deformation as small as one-millionth of an inch. The net result is that weak areas are caught in test, not on job sites where costly downtime occurs.
 - All outrigger, lift and telescoping cylinders are manufactured by National Crane, so that the seals, packing glands, and end plates are traced for accurate shipment of replacement parts.
 - Parts are available for all National Crane machines, even if they are 35 years old.
 - National has a formalized quality program and is ISO 9001 approved.
- **National Crane Is a Quality Product That Will Provide Years of Service**

- 10-ton (9.07 t) maximum capacity
- 84 ft. (25.60 m) maximum vertical reach with jib*
- 66 ft. (20.11 m) maximum vertical hydraulic reach main boom*
- Hydraulic Capacity Alert system (HCA)
- Proportional boom extension
- High performance planetary winch
- Maximum vertical reach is ground-level to boom tip height at maximum extension and angle with outriggers/stabilizers fully extended.

400B

mounting configurations

The configurations are based on the Series 400B with an 85% stability factor. The complete unit must be installed in accordance with factory requirements and a test performed to determine actual stability and counterweight requirements since individual truck chassis vary.

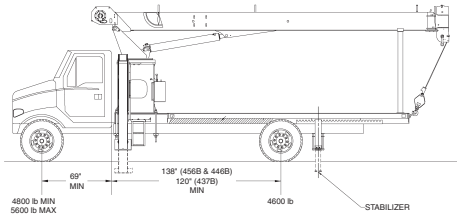

Configuration 1 with Subbase

Working area	180°
Gross Axle Weight Rating Front	9,000 lb (4082 kg)
Gross Axle Weight Rating Rear	19,000 lb (8618 kg)
Gross Vehicle Weight Rating	28,000 lb (12 700 kg)
Wheelbase	184 in (650 cm) on 437B, 207 in (526 cm) on 446B, 456B
Cab to Axle/trunnion (CA/CT)	120 in (305 cm) on 437B, 138 in (351 cm) on 446B, 456B
Frame Section Modulus (SM) under crane w/110,000 PSI (758 MPa)	10.0 in ² (164 cm ²)
Frame Section Modulus (SM) over rear stabilizers: 110,000 PSI (758 MPa)	10.0 in ² (164 cm ²)
Stability Weight, Front	4,800 lb (2177 kg) minimum, 5,600 lb (2540 kg) maximum*
Stability Weight, Rear	4,600 lb (2087 kg) minimum*
Estimated Average Final Weight	21,000 lb (9524 kg)**

Allows the installation of Series 400B on a chassis with small frame by using standard subbase. In most cases, chassis will not require reinforcing and counterweight will not be required. This configuration gives a payload of app. 6,000 lbs (2722 kg) on minimum truck. Requires standard subbase and rear stabilizers. Full capacity work area in rear 180° of vehicle from outrigger to outrigger.

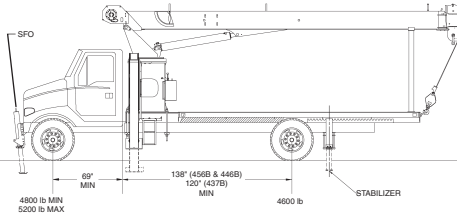

Configuration 2 with Subbase and SFO

Working area	360°
Gross Axle Weight Rating Front	9,000 lb (4082 kg)
Gross Axle Weight Rating Rear	19,000 lb (8618 kg)
Gross Vehicle Weight Rating	28,000 lb (12 700 kg)
Wheelbase	184 in (650 cm) on 437B, 207 in (526 cm) on 446B, 456B
Cab to Axle/trunnion (CA/CT)	120 in (305 cm) on 437B, 138 in (351 cm) on 446B, 456B
Frame Section Modulus (SM) under crane w/110,000 PSI (758 MPa)	10.0 in ² (164 cm ²)
Frame Section Modulus (SM) over rear stabilizers: 110,000 PSI (758 MPa)	10.0 in ² (164 cm ²)
Stability Weight, Front	4,800 lb (2177 kg) minimum, 5,200 lb (2359 kg) maximum*
Stability Weight, Rear	4,600 lb (2087 kg) minimum*
Estimated Average Final Weight	21,400 lb (9707 kg)**

Requires front stabilizer for full capacity 360° around the truck. Requires front and rear stabilizers and standard subbase. Front stabilizer for this configuration requires 13.5 inch³ (50,000 PSI), or 6.2 inch³ (110,000 PSI) section modulus from back of the front spring hangers through front suspension and to the front stabilizer. Normally a tapered front frame cannot be reinforced to these minimums.

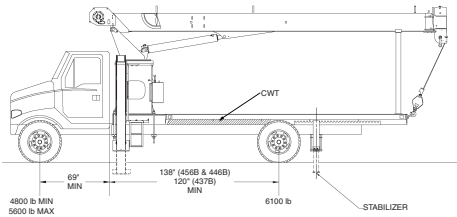

Configuration 3 with Subbase and Counterweight

Working area	360°
Gross Axle Weight Rating Front	9,000 lb (4082 kg)
Gross Axle Weight Rating Rear	19,000 lb (8618 kg)
Gross Vehicle Weight Rating	28,000 lb (12 700 kg)
Wheelbase	184 in (650 cm) on 437B, 207 in (526 cm) on 446B, 456B
Cab to Axle/trunnion (CA/CT)	120 in (305 cm) on 437B, 138 in (351 cm) on 446B, 456B
Frame Section Modulus (SM) under crane w/110,000 PSI (758 MPa)	10.0 in ² (164 cm ²)
Frame Section Modulus (SM) over rear stabilizers: 110,000 PSI (758 MPa)	10.0 in ² (164 cm ²)
Stability Weight, Front	4,800 lb (2177 kg) minimum, 5,600 lb (2540 kg) maximum*
Stability Weight, Rear	6,100 lb (2767 kg) minimum*
Estimated Average Final Weight	22,500 lb (10 206 kg)**

Allows 360° stability at full capacity without front stabilizer. Requires additional weight at rear of the truck to reduce loading on the front axle when lifting over the front. This mount is recommended only for occasional lifting over the front of the vehicle. If continually lifting over the front, the vehicle must be equipped with front stabilizer to eliminate fatigue on front axle components. Requires rear stabilizers and standard subbase with counterweight in subbase or underside of bed.

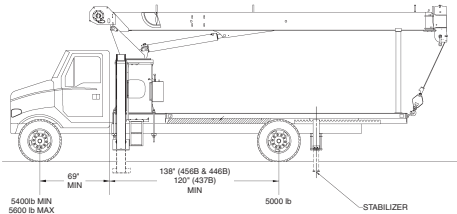

Configuration 4 without Subbase

Working area	180°
Gross Axle Weight Rating Front	9,000 lb (4082 kg)
Gross Axle Weight Rating Rear	19,000 lb (8618 kg)
Gross Vehicle Weight Rating	28,000 lb (12 700 kg)
Wheelbase	184 in (650 cm) on 437B, 207 in (526 cm) on 446B, 456B
Cab to Axle/trunnion (CA/CT)	120 in (305 cm) on 437B, 138 in (351 cm) on 446B, 456B
Frame Section Modulus (SM) under crane w/110,000 PSI (758 MPa)	15.0 in ² (246 cm ²)
Frame Section Modulus (SM) over rear stabilizers: 110,000 PSI (758 MPa)	10.0 in ² (164 cm ²)
Stability Weight, Front	5,400 lb (2445 kg) minimum, 5,600 lb (2540 kg) maximum*
Stability Weight, Rear	5,000 lb (2268 kg) minimum*
Estimated Average Final Weight	22,500 lb (10 206 kg)**

The Series 400B can be mounted without the factory-furnished subbase provided the truck is above minimum specifications for truck frame strength and chassis weight. A 400B mounted in this manner will be 180° stable over the rear of the vehicle from outrigger to outrigger.

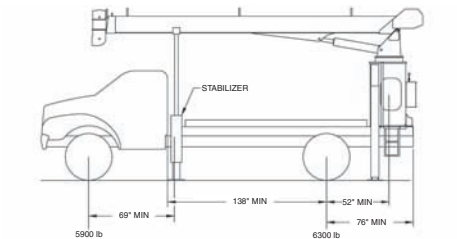

Configuration 5 - Rear Mount with HD Subbase

Working area	360°
Gross Axle Weight Rating Front	9,000 lb (4082 kg)
Gross Axle Weight Rating Rear	19,000 lb (8618 kg)
Gross Vehicle Weight Rating	28,000 lb (12 700 kg)
Wheelbase	207 in (526 cm)
Cab to Axle/trunnion (CA/CT)	138 in (351 cm)
After Frame (AF)	76 in (193 cm) minimum
Frame Section Modulus (SM) under crane w/110,000 PSI (758 MPa)	13.0 in ² (213 cm ²)
Frame Section Modulus (SM) over rear stabilizers: 110,000 PSI (758 MPa)	13.0 in ² (213 cm ²)
Stability Weight, Front	5,900 lb (2676 kg) minimum*
Stability Weight, Rear	6,800 lb (3084 kg) minimum*
Estimated Average Final Weight	24,500 lb (11 113 kg)**

The advantages of a rear-mounted Series 400B are: (1) it allows the operator to effectively use the close-in working area to lift heavier loads, and (2) 360° solid stability at full rated load. Counterweight up to 3,000 pounds will be required on a minimum truck. With this configuration, a payload of approximately 3,500 lbs (1588 kg) can be hauled on a minimum truck. Underframe stabilizers behind the cab may interfere with the drive line or cause ground clearance problems. If so, contact the factory for alternatives.

Notes:

- Gross Vehicle Weight rating (GVWR) is dependent on all components of the vehicle (axles, tires, springs, frame, etc.) meeting manufacturers' recommendations; always specify GVWR when purchasing trucks
- Diesel engines require a variable speed governor and energize-to-run fuel solenoid for smooth crane operation; electronic fuel injection requires EET engine remote throttle

- All mounting data is based on a National Series 400B with an 85 percent stability factor
- The complete unit must be installed in accordance with factory requirements, and a test performed to determine actual stability and counterweight requirements per SAE J765; contact the factory for details
- Transmission neutral safety interlock switch is required with optional remote control

*Estimated axle scale weights prior to installation of crane, stabilizers and subbase for 85% stability.

**Includes all standard crane components, 456B boom, rear bumper, boom rest and bed.

3

400B

specifications

Boom and Jib Combinations Data

Available in three basic models.

4 Model 437B – Equipped with a 15' 2"-37 ft (4.62-11.28 m) three-section boom. Maximum tip height is 47 ft (14.32 m).

15'2"-37 (4.62-11.28 m) three-section



Model 446B – Equipped with an 18' 2"-46 ft (5.54-14.02 m) three-section boom. This model can be equipped with an 18 ft (5.49 m) single section jib. Maximum tip height w/18 ft (5.49 m) jib is 74 ft (22.55 m).

18'2"-46 (5.54-14.02 m) three-section boom



18'2"-46 (5.54-14.02 m) three-section boom

4FJ18 18 ft (5.49 m) jib



Model 456B – Equipped with a 21' 6"-56 ft. (6.55-17.07 m) three-section boom. This model can be equipped with an 18 ft (5.49 m) single section jib. Maximum tip height w/18 ft (5.49 m) jib is 84 ft (25.60 m).

21'6"-56 ft (6.55-17.07 m) three-section boom.



21'6"-56 ft. (6.55-17.07 m) three-section boom







4FJ18 18 ft (5.49 m) jib



Note: Maximum tip is measured with outriggers/stabilizers fully extended.

400B Winch Data

- All winch pulls and speeds in this chart are shown on the third layer
- Winch line pulls would increase on the first and second layers
- Winch line speed would decrease on the first and second layers
- Winch line pulls may be limited by the winch capacity or the ANSI 5 to 1 cable safety factor
- Hook blocks are rated at maximum capacity for the block. **Do not exceed rated cable pull with any block.**

Winch	Cable Supplied	Average Breaking Strength	1 Part Line	2 Part Line	3 Part Line	4 Part Line
			Lift and Speed	Lift and Speed	Lift and Speed	Lift and Speed
Standard Planetary Winch	Standard 1/2" Diameter Rotation Resistant	29,200 lb (13 250 kg)	 5,840 lb (2650 kg) 184 fpm (56 m/min)	 11,680 lb (5300 kg) 92 fpm (28 m/min)	 17,520 lb (7950 kg) 61 fpm (19 m/min)	 20,000 lb (9075 kg) 46 fpm (14 m/min)
Optional High-pull Planetary Winch	Standard 9/16" Diameter Rotation Resistant	38,500 lb (17 463 kg)	 7,700 lb (3493 kg) 110 fpm (34 m/min)	 15,400 lb (6985 kg) 55 fpm (17 m/min)	 20,000 lb (9075 kg) 37 fpm (11 m/min)	N/A N/A

Winch	Bare Drum Pull	Std. Cable Limited
Standard Planetary	6,900 lb (3130 kg)	5,840 lb (2650 kg)
Optional Planetary.....	10,200 lb (4627 kg)	7,700 lb (3493 kg)

Block Type	Rating	Weight
Downhaul Weight.....	4.2 ton (3.8 t)	90 lb (68 kg)
1 Sheave Block.....	9 ton (8.16 t)	100 lb (91 kg)
2 Sheave Block.....	22 ton (19.96 t)	355 lb (161 kg)

400B

capacities

5

Load Rating Chart: Series 456B with 18 ft. Jib

Other series 400B Load Rating Charts are available. National will send you a chart on request – or you may secure needed load rating information through your nearest National dealer.

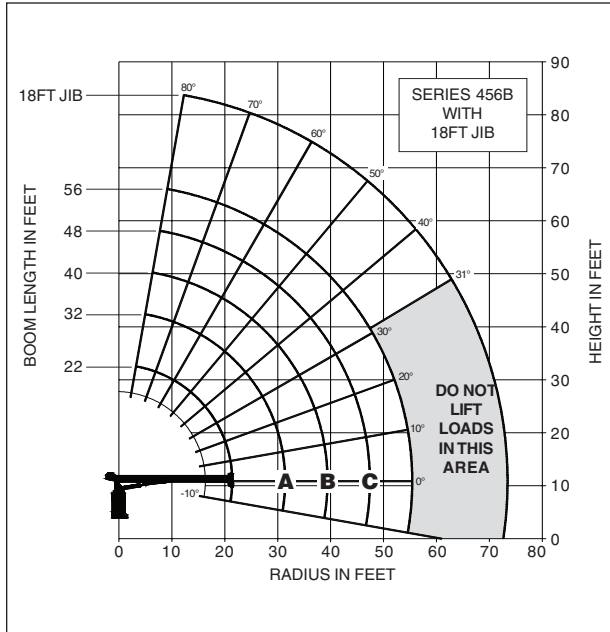

CAUTION:

- Do not operate crane booms, jib extensions, any accessories or loads within 10 ft (3m) of live power lines or other conductors of electricity.
- Jib and boom capacities shown are maximum for each section.
- Do not exceed capacities at reduced radii.
- Load ratings shown on the load rating charts are maximum allowable loads with the outriggers properly extended on a firm, level surface and the crane leveled and mounted on a factory recommended truck.
- Always level the crane with the level indicator located on the crane.
- The operator must reduce load to allow for factors such as wind, ground conditions, operating speeds and their effects on freely suspended loads.
- Overloading this crane may cause structural collapse or instability.
- Weights on any accessories attached to the boom or loadline must be deducted from the load chart capacities.
- Do not exceed jib capabilities at any reduced boom lengths.
- Do not deadhead lineblock against boom tip when extending boom or winching up.
- Keep at least three wraps of loadline on drum at all times.
- Use only specified cable with this machine.

**SERIES 456B
WITH
18 FT JIB**

NOTE:

1. Operate with jib by radius when main boom is fully extended. If necessary increase boom angle to maintain loaded radius.
2. Operate with jib by boom angle when main boom is not fully extended. Do not exceed rated jib capacities at any reduced boom lengths.

LOADLINE EQUIPMENT DEDUCT (lb)	
Downhaul weight	90
One sheave block	185
Two sheave block	355

Load Rating: Series 456B with 18 ft. Jib

LOAD RADIUS (FEET)	LOADED BOOM ANGLE	22FT BOOM (lb)	LOADED BOOM ANGLE	A 32FT BOOM (lb)	LOADED BOOM ANGLE	B 40FT BOOM (lb)	LOADED BOOM ANGLE	C 48FT BOOM (lb)	LOADED BOOM ANGLE	56FT BOOM (lb)	LOAD RADIUS (FEET)	LOADED BOOM ANGLE	18FT JIB (lb)
5	77.5	20,000											
6	74.5	17,300											
8	70	12,800	76.5	10,950	79.5	10,400							
10	63	10,000	73	8,850	77	8,650							
12	56.5	8,800	69	7,650	74	7,250	76.5	7,150					
14	50	7,800	65	6,850	70.5	6,350	75	6,150	77	5,900	14	80	2,800
16	42.5	6,900	61	6,050	68.5	5,650	72.5	5,400	75.5	5,150	16	78.5	2,700
18	34	6,100	57.5	5,450	65	5,150	69.5	4,900	73.5	4,600	18	77	2,500
20	23	5,400	53	5,050	62	4,750	67.5	4,600	71	4,200	20	75.5	2,300
25			40.5	4,050	53.5	3,850	61	3,700	65.5	3,400	25	72	2,050
30			22.5	3,200	43.5	3,150	53.5	3,000	60	2,800	30	68	1,750
35					31	2,600	45.5	2,600	53.5	2,400	35	63.5	1,500
40							36	2,100	46.5	2,000	40	59	1,300
45							22.5	1,750	39	1,650	45	54.5	1,100
50									29	1,400	50	49.5	1,000
55									13	1,050	55	44	850
60											60	38	750
65											65	31	650
	0	4,050	0	2,350	0	1,650	0	1,250	0	850			

THIS CHART IS ONLY A GUIDE AND SHOULD NOT BE USED TO OPERATE THE CRANE. The individual crane's load chart, operating instructions and other instructional plates must be read and understood prior to operating the crane.

capacities

Load Rating Chart: Series 456B with No Jib

6

Other series 400B Load Rating Charts are available. National will send you a chart on request – or you may secure needed load rating information through your nearest National dealer.

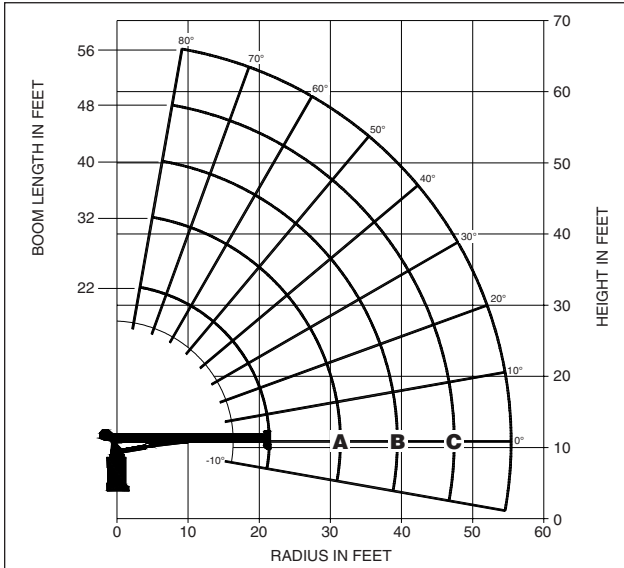

**SERIES 456B
WITH
NO JIB**

LOADLINE EQUIPMENT DEDUCT (lb)

Downhaul weight _____ 90
One sheave block _____ 185
Two sheave block _____ 355

CAUTION:

- Do not operate crane booms, jib extensions, any accessories or loads within 10 ft (3m) of live power lines or other conductors of electricity.
- Jib and boom capacities shown are maximum for each section.
- Do not exceed capacities at reduced radii.
- Load ratings shown on the load rating charts are maximum allowable loads with the outriggers properly extended on a firm, level surface and the crane leveled and mounted on a factory recommended truck.
- Always level the crane with the level indicator located on the crane.
- The operator must reduce load to allow for factors such as wind, ground conditions, operating speeds and their effects on freely suspended loads.
- Overloading this crane may cause structural collapse or instability.
- Weights on any accessories attached to the boom or loadline must be deducted from the load chart capacities.
- Do not exceed jib capabilities at any reduced boom lengths.
- Do not deadhead lineblock against boom tip when extending boom or winching up.
- Keep at least three wraps of loadline on drum at all times.
- Use only specified cable with this machine.

Load Rating Chart: Series 456B with No Jib

LOAD RADIUS (FEET)	LOADED BOOM ANGLE	22FT BOOM (lb)	LOADED BOOM ANGLE	A 32FT BOOM (lb)	LOADED BOOM ANGLE	B 40FT BOOM (lb)	LOADED BOOM ANGLE	C 48FT BOOM (lb)	LOADED BOOM ANGLE	56FT BOOM (lb)	
5	77.5	20,000									
6	74.5	17,500									
8	70	13,000	76.5	11,100	79.5	10,550					
10	63	10,200	73	9,000	77	8,800					
12	56.5	9,000	69	7,800	74	7,400	76.5	7,250			
14	50	8,000	65	7,000	70.5	6,500	75	6,250	77	6,000	
16	42.5	7,100	61	6,200	68.5	5,800	72.5	5,500	75.5	5,250	
18	34	6,300	57.5	5,600	65	5,300	69.5	5,000	73.5	4,700	
20	23	5,600	53	5,200	62	4,900	67.5	4,700	71	4,300	
25			40.5	4,200	53.5	4,000	61	3,800	65.5	3,500	
30			22.5	3,350	43.5	3,300	53.5	3,100	60	2,900	
35						31	2,750	45.5	2,700	53.5	2,500
40								36	2,200	46.5	2,100
45								22.5	1,850	39	1,750
50										29	1,500
55										13	1,150
	0	4,250	0	2,500	0	1,800	0	1,350	0	950	

400B

THIS CHART IS ONLY A GUIDE AND SHOULD NOT BE USED TO OPERATE THE CRANE. The individual crane's load chart, operating instructions and other instructional plates must be read and understood prior to operating the crane.

Radio Remote Controls –

Eliminate the handling and maintenance concerns that accompany cabled remotes. Operate to a range of about 250 feet (76 m), varying with conditions.

- **Model R4BR**

One-Person Basket –

Strong but lightweight steel basket with 300-lb (139-kg) capacity, gravity hung with swing lock and full body harness.

- **Model B1-S**
- **Model 2B1-S** (for dual locking baskets)

Hi-Pull Planetary Winch with Rotation-Resistant Wire Rope –

- **Model HIP**

Rear mount and tractor mount configurations available.

Dimensions Specifications

SERIES		DRY WEIGHT*	W/OIL WEIGHT*
456B	47" G [1194mm]	8100 LBS [3675kg]	8425 LBS [3825kg]
446B	36" [914mm]	7775 LBS [3525kg]	8100 LBS [3675kg]
437B	29" [737mm]	7450 LBS [3375kg]	7775 LBS [3525kg]

*ABOVE WEIGHTS DO NOT INCLUDE SUBBASE, REAR STABILIZERS, JIBS, PTO, PUMP, BOOM RESTS OR OPTIONS

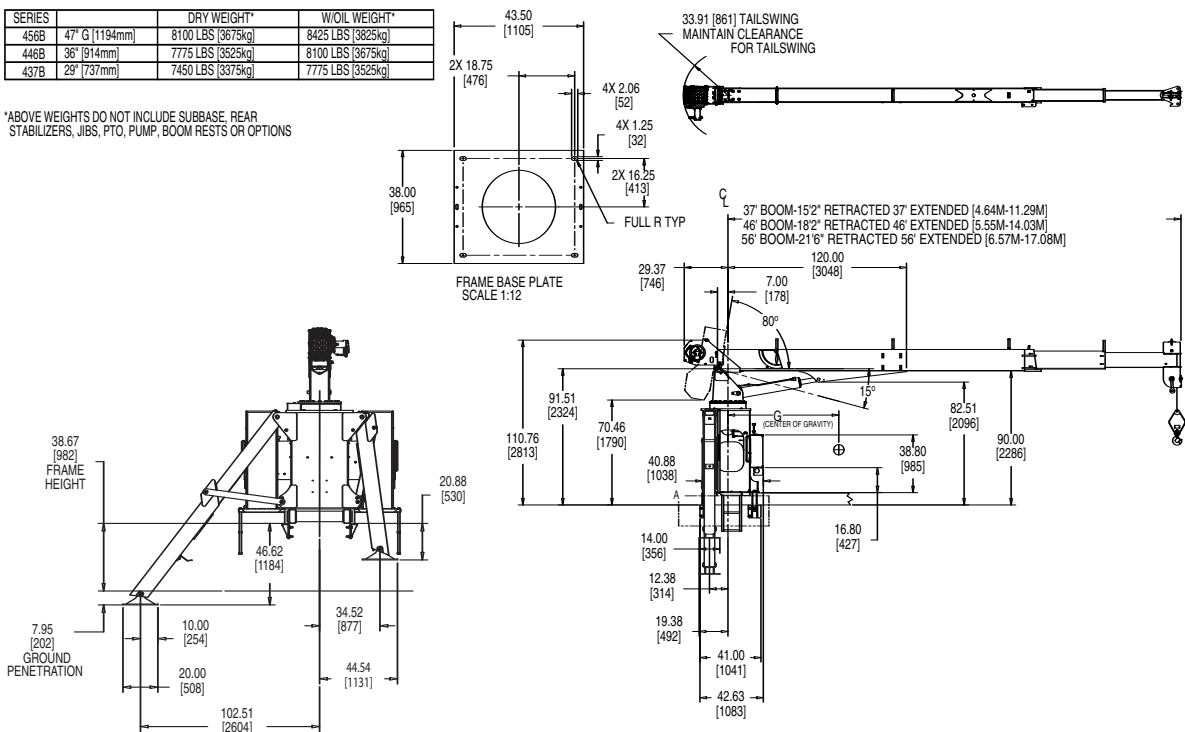

400B



Manitowoc Crane Group - Americas

Manitowoc, Wisconsin Facility
Tel: [Int + 001] 920 684 6621
Fax: [Int + 001] 920 683 6277
Shady Grove, Pennsylvania Facility
Tel: [Int + 001] 717 597 8121
Fax: [Int + 001] 717 597 4062

Manitowoc Crane Group - EMEA

Europe Middle East & Africa
Tel: [Int + 33] (0) 472 18 20 20
Fax: [Int + 33] (0) 472 18 20 00

Manitowoc Crane Group - UK

Europe Middle East & Africa
Tel: [Int + 44] (0) 191 565 6281
Fax: [Int + 44] (0) 191 564 0442

Manitowoc Crane Group - Germany

(Sales, Parts & Service)
Tel: [Int + 49](0) 2173 8909 0
Fax: [Int + 49] (0) 2173 8909-30

Manitowoc Crane Group - France

France & Africa (Sales, Parts & Service)
Tel: [Int + 33] (0) 1 303 13150
Fax: [Int + 33] (0) 1 303 86085

Manitowoc Crane Group - Netherlands

(Sales, Parts & Service)
Tel: [Int + 31] (0) 76 578 39 99
Fax: [Int + 31] (0) 76 578 39 78

Manitowoc Crane Group - Italy

Italy & Southern Europe (Sales, Parts & Service)
Tel: [Int + 39] (0) 331 49 33 11
Fax: [Int + 39] (0) 331 49 33 30

Manitowoc Crane Group - Portugal

Portugal & Spain (Sales, Parts & Service)
Tel: [Int + 351] (0) 22 968 08 89
Fax: [Int + 351] (0) 22 968 08 97

Manitowoc Crane Group - Singapore

Asia/Pacific excl China (Sales, Parts & Service)
Tel: [Int + 65] 6861 1733
Fax: [Int + 65] 6862 4040 / 4142

Manitowoc Crane Group - Shanghai

China (Sales, Parts & Service)
Tel: [Int + 86] (0) 21 64955555
Fax: [Int + 86] (0) 2164852038

Manitowoc Crane Group - Beijing

China (Sales, Parts & Service)
Tel: [Int + 86] (0) 10 646 71690
Fax: [Int + 86] (0) 10 646 71691

Manitowoc Crane Group - Middle East

Sales
Tel: [Int + 971] (0) 4 348 4478
Fax: [Int + 971] (0) 4 348 4478
(Parts & Service)
Tel: [Int + 973] (0) 9 660 899
Fax: [Int + 973] (0) 2 707 740

Distributed By:



www.manitowoccrane.com

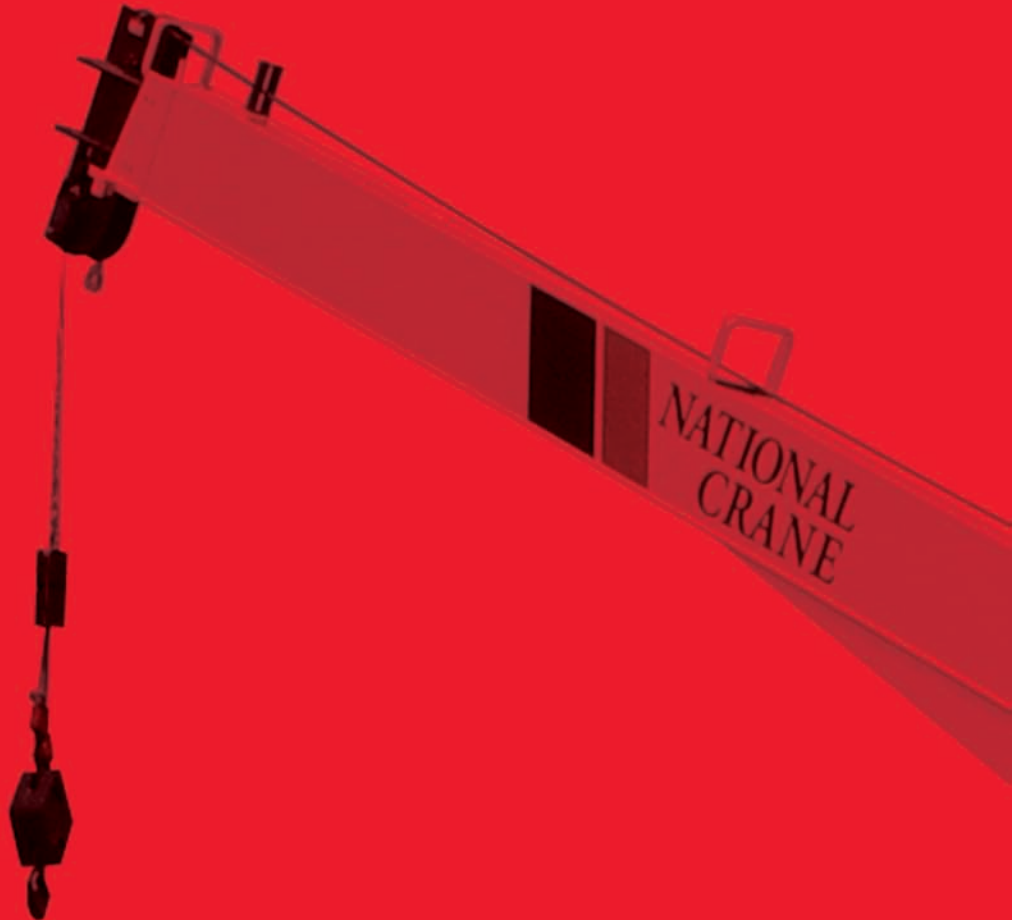

Constant improvement and engineering progress make it necessary that we reserve the right to make specification, equipment, and price changes without notice. *Illustrations/photos shown may include optional equipment and accessories, and may not include all standard equipment.